

CODIGO **40982**

DESCRIPCION: **ASIENTO HIDROMASAJE LINER 600MM**

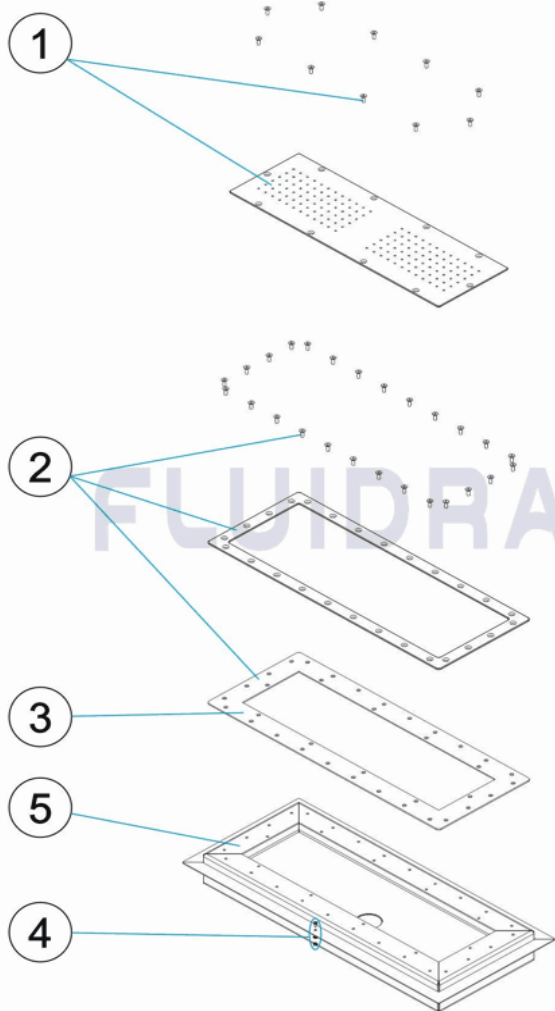

ESPAÑOL

POS	CODIGO	DESCRIPCION	CANTIDAD	POS	CODIGO	DESCRIPCION	CANTIDAD
1	4402030001	REJA HIDROMASAJE		4	4410010015	TOMA DE TIERRA	
2	4402030002	MARCO REJA		5	40982R0100	CUERPO REJA HIDROMASAJE	
3	4402030003	JUNTA REJA					

CODE **40982**

DESCRIPTION: **SIÈGE HYDROMASSAGE LINER 600MM**

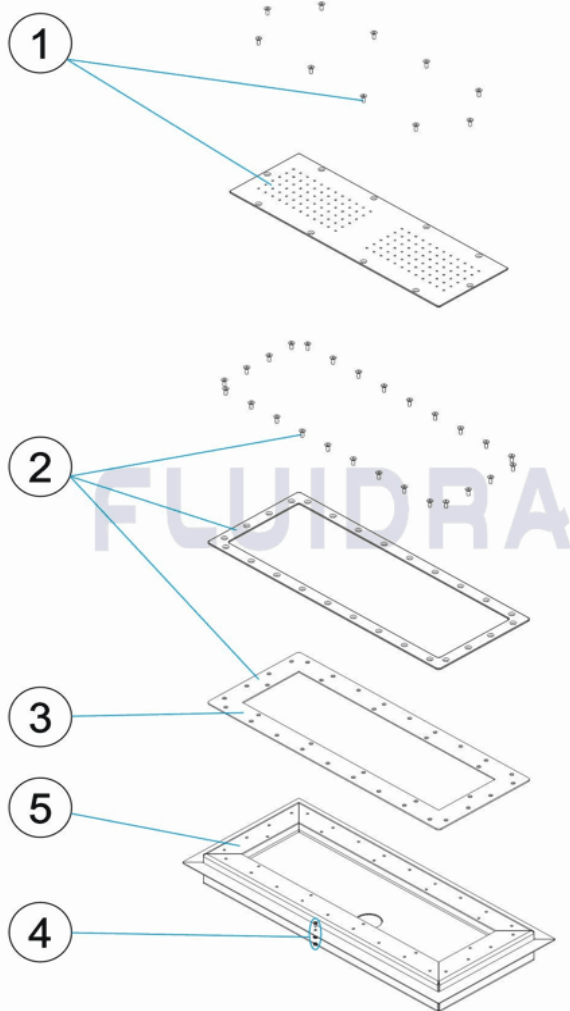

FRANCAIS

POS	CODE	DESCRIPTION	QUANTITE	POS	CODE	DESCRIPTION	QUANTITE
1	4402030001	GRILLE HYDROMASSAGE		4	4410010015	PRISE DE TERRE	
2	4402030002	CADRE GRILLE		5	40982R0100	CORPS GRILLE HYDROMASSAGE	
3	4402030003	JOINT GRILLE					

CODE **40982**

DESCRIPTION: **LINER HYDROMASSAGE SEAT 600MM**

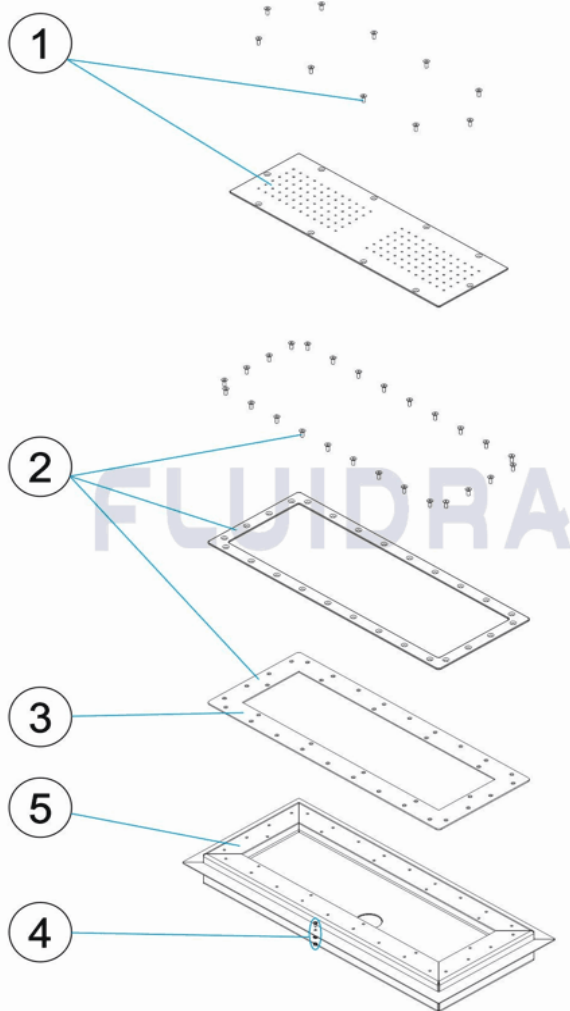

ENGLISH

POS	CODE	DESCRIPTION	QUANTITY	POS	CODE	DESCRIPTION	QUANTITY
1	4402030001	HYDROMASSAGE GRILL		4	4410010015	EARTH CONNECTION	
2	4402030002	GRILL FRAME		5	40982R0100	HYDROMASSAGE GRILL BODY	
3	4402030003	GRILL GASKET					

CODICE **40982**

DESCRIZIONE: **SEIDA IDROMASSAGGIO LINER 600MM**

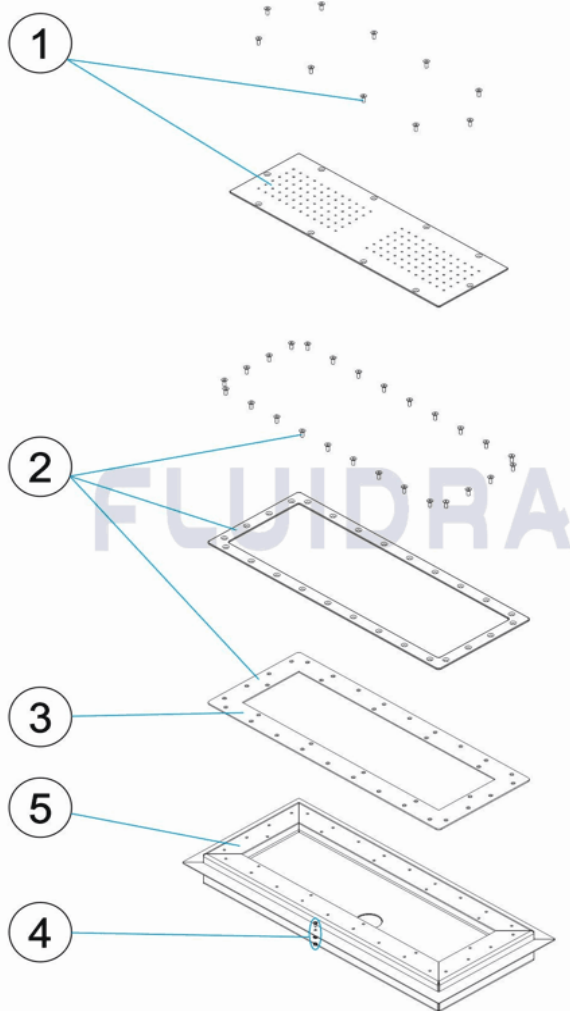

ITALIANO

POS	CODICE	DESCRIZIONE	QUANTITA'	POS	CODICE	DESCRIZIONE	QUANTITA'
1	4402030001	GRIGLIA IDROMASSAGGIO		4	4410010015	PRESA A TERRA	
2	4402030002	CORNICE GRIGLIA		5	40982R0100	CORPO GRIGLIA IDROMASSAGGIO	
3	4402030003	GUARNIZIONE GRIGLIA					

CODE **40982**

BESCHREIBUNG: **SITZ HYDROMASSAGE LINER 600MM**

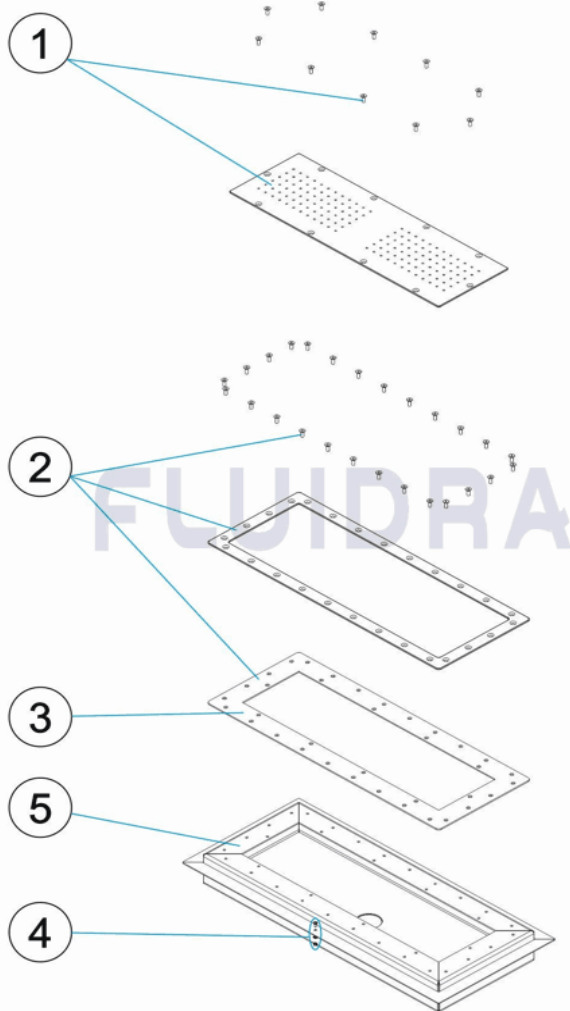

DEUTSCH

POS	CODE	BESCHREIBUNG	MENGE	POS	CODE	BESCHREIBUNG	MENGE
1	4402030001	HYDROMASSAGEGITTER		4	4410010015	ERDUNG	
2	4402030002	GITERRAHMEN		5	40982R0100	HYDROMASSAGEGITTER GEHÄUSE	
3	4402030003	ANSAUGGITTER DICHTUNG					

CODIGO **40982**

DESCRIÇÃO: **CADEIRA HIDROMASSAGEM LINER 600MM**

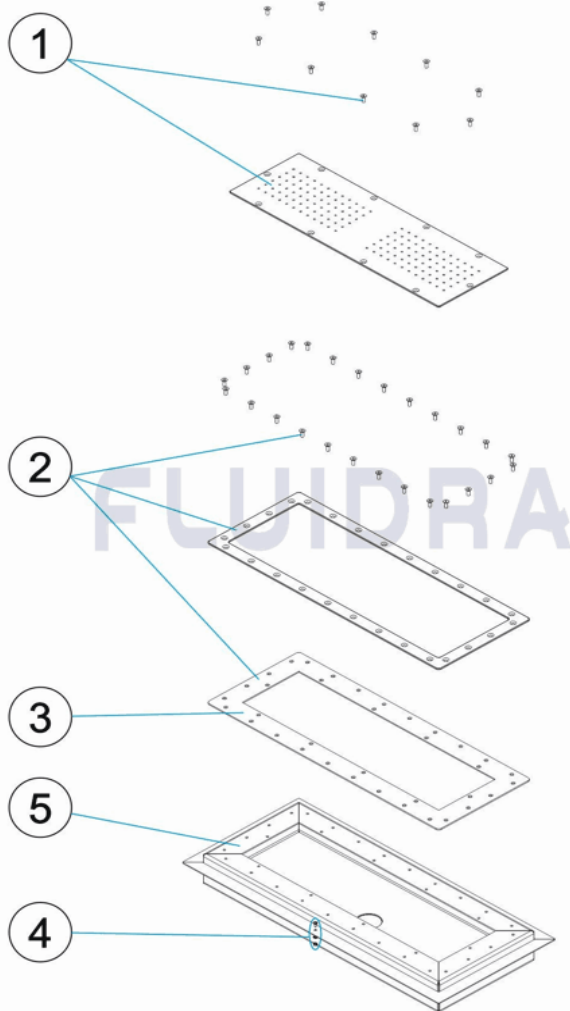

PORTUGUES

POS	CODIGO	DESCRIÇÃO	JANTIDADE	POS	CODIGO	DESCRIÇÃO	JANTIDADE
1	4402030001	GRELHA HIDROMASSAGEM		4	4410010015	LIGAÇÃO A TERRA	
2	4402030002	MARCO DA GRELHA		5	40982R0100	CORPO GRELHA HIDROMASSAGEM	
3	4402030003	JUNTA GRADE					